

8 7 6 5 4 3 2 1

D
C
B
A

D
C
B
A

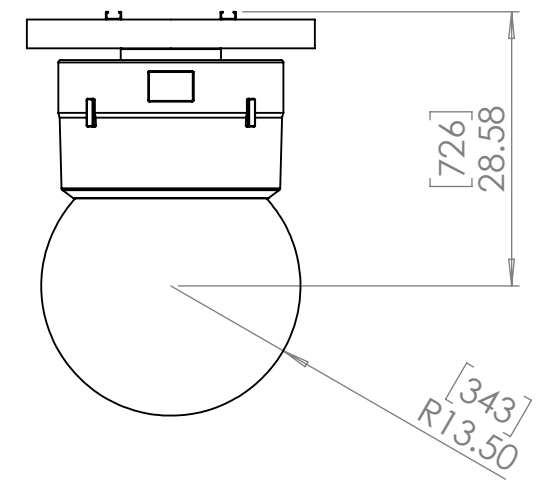
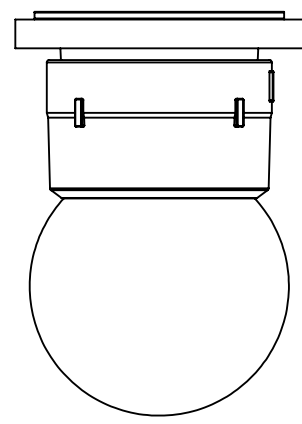
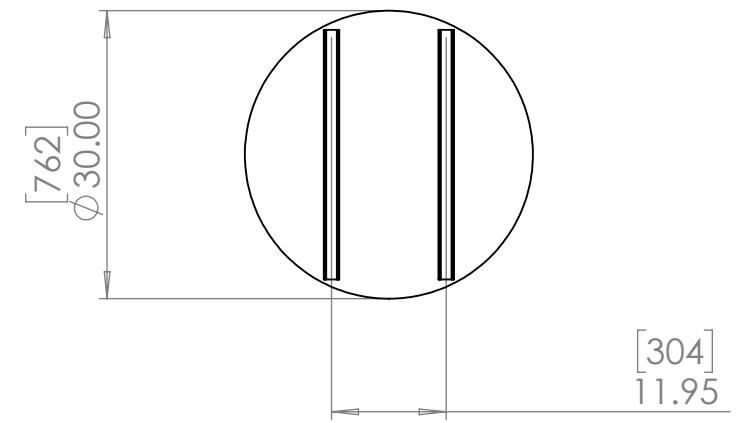
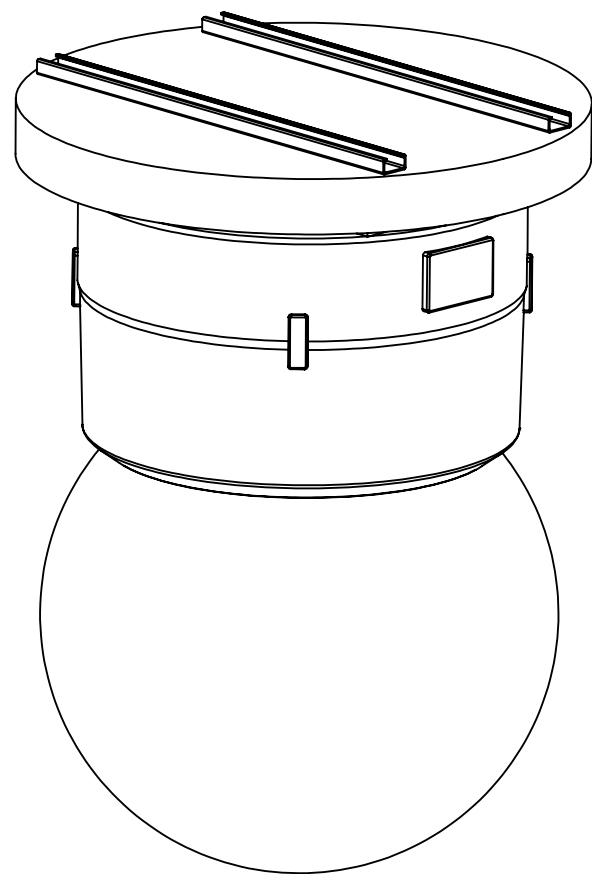

UNLESS OTHERWISE SPECIFIED:
DIMENSIONS ARE IN INCHES
TOLERANCES:
FRACTIONAL ±
FRACTIONAL ±
ANGULAR: MACH ± BEND ±
TWO PLACE DECIMAL ±
THREE PLACE DECIMAL ±
INTERPRET GEOMETRIC
TOLERANCING PER:
MATERIAL
FINISH
DO NOT SCALE DRAWING

	NAME	DATE
DRAWN	TB	5/4/2017
CHECKED		
ENG APPR.		
MFG APPR.		
Q.A.		
COMMENTS:		



TEMPEST
lighting inc.

TITLE:
Tornado G4 1925, Globe Down

SIZE	DWG. NO.	REV
B	1925.xxGV	01

SCALE: 1:20 SHEET 1 OF 1

8 7 6 5 4 3 2 1