

8 7 6 5 4 3 2 1

D
C
B
A

D
C
B
A

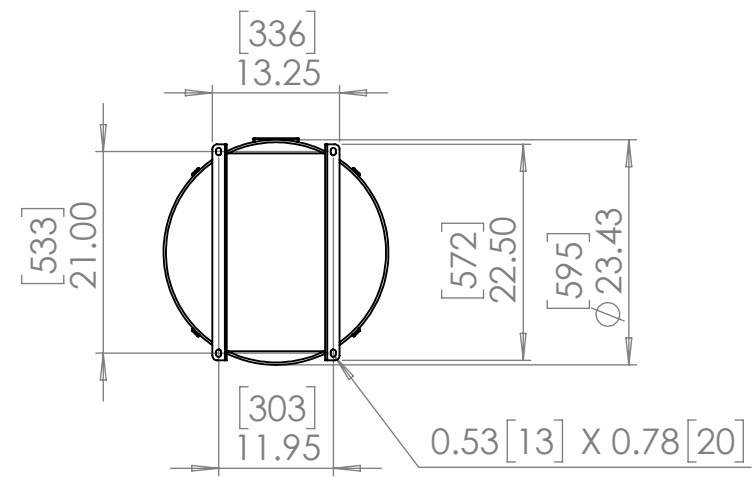
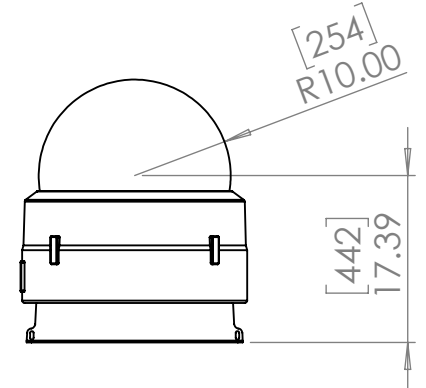
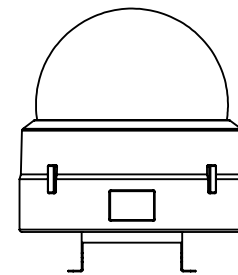
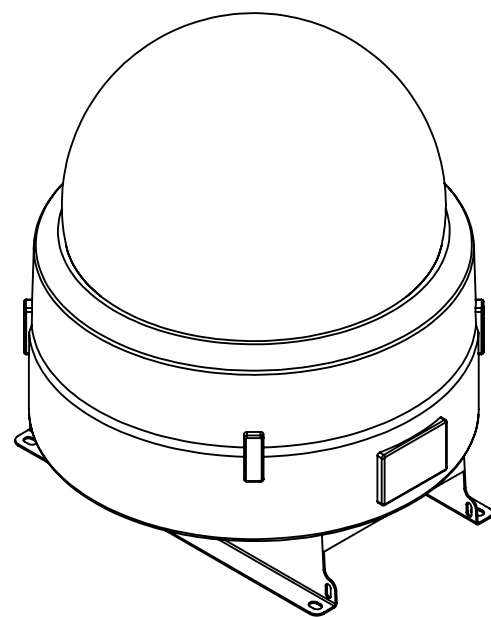

UNLESS OTHERWISE SPECIFIED:
 DIMENSIONS ARE IN INCHES
 TOLERANCES:
 FRACTIONAL ±
 ANGULAR: MACH ± BEND ±
 TWO PLACE DECIMAL ±
 THREE PLACE DECIMAL ±
 INTERPRET GEOMETRIC
 TOLERANCING PER:
 MATERIAL
 FINISH
 DO NOT SCALE DRAWING

	NAME	DATE
DRAWN	TB	5/4/2017
CHECKED		
ENG APPR.		
MFG APPR.		
Q.A.		
COMMENTS:		



TEMPEST
lighting inc.

TITLE:
Tornado G4 1850, Globe
Up

SIZE	DWG. NO.	REV
B	1850.xxG	01

SCALE: 1:20 SHEET 1 OF 1

8 7 6 5 4 3 2 1