

8 7 6 5 4 3 2 1

D

C

B

A

D

C

B

A

Rigging Points:  
M12-1.75, 6 places,  
Top Surface

Power & Signal Conduit Entries

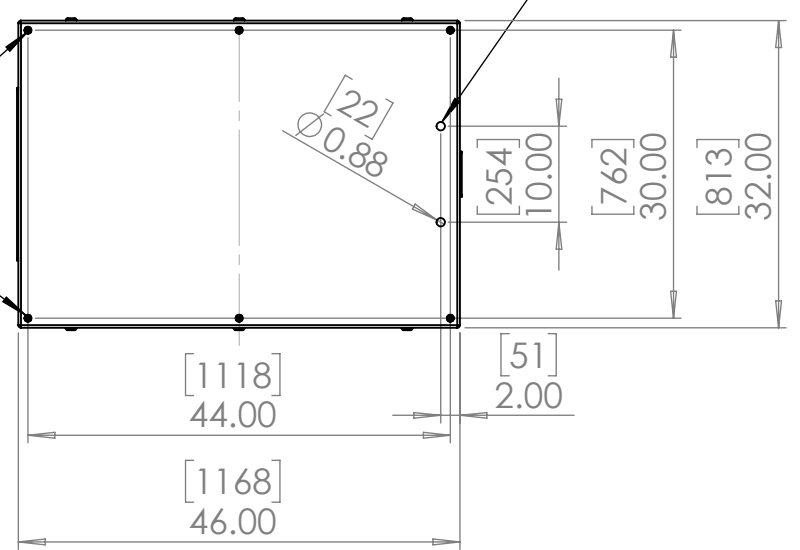

Exhaust Vents  
(do not obstruct)

User Interface

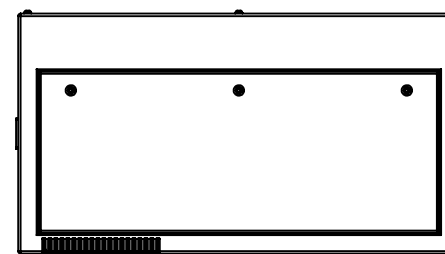
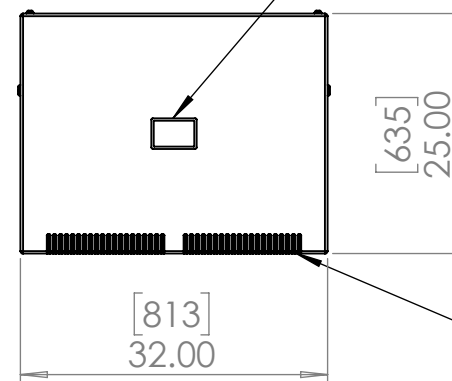
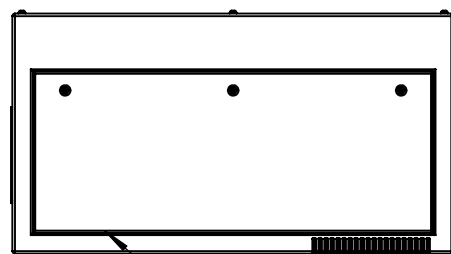
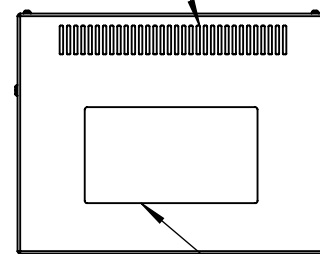

Optical Grade  
Port Glass

Lockable Access  
Door, both sides

Inlet Vents  
(do not obstruct)

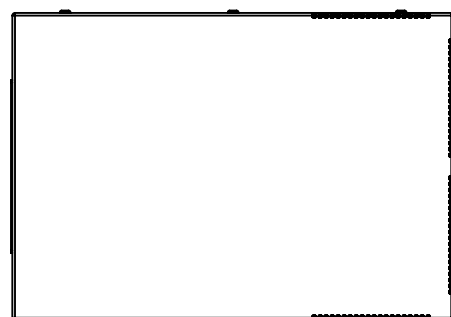
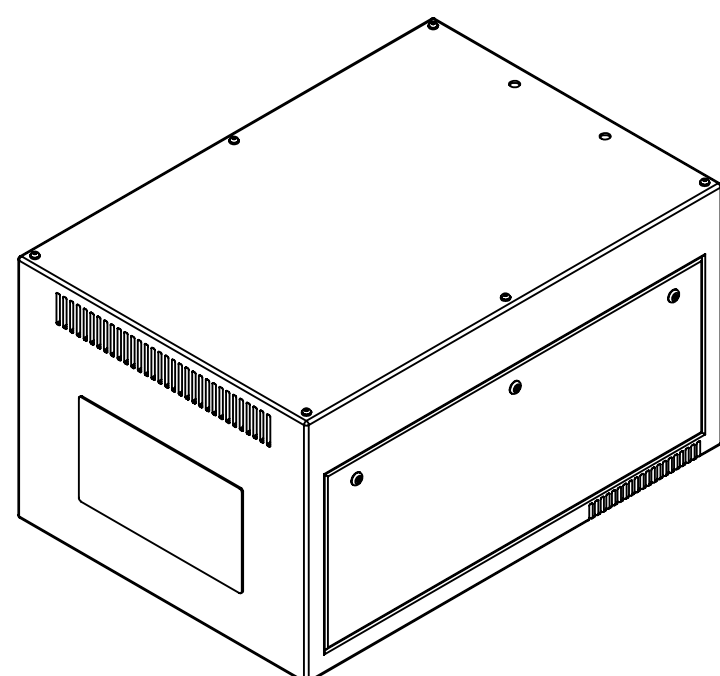

UNLESS OTHERWISE SPECIFIED:  
DIMENSIONS ARE IN INCHES  
TOLERANCES:  
FRACTIONAL ±  
ANGULAR: MACH ± BEND ±  
TWO PLACE DECIMAL ±  
THREE PLACE DECIMAL ±  
INTERPRET GEOMETRIC  
TOLERANCING PER:  
MATERIAL  
Aluminum  
FINISH  
Powder Coat RAL  
9003 White  
DO NOT SCALE DRAWING

	NAME	DATE
DRAWN	TB	1/15/2019
CHECKED		
ENG APPR.		
MFG APPR.		
Q.A.		
COMMENTS:		

**TEMPEST**  
lighting inc.

TITLE:  
Zen 150 Hush Enclosure

SIZE <b>B</b>	DWG. NO. 57.150	REV 03
------------------	--------------------	-----------

SCALE: 1:20 SHEET 1 OF 1

8 7 6 5 4 3 2 1