

IMPORTANT:

For Remote Fan Assembly information, see drawing # 51.RFA.11

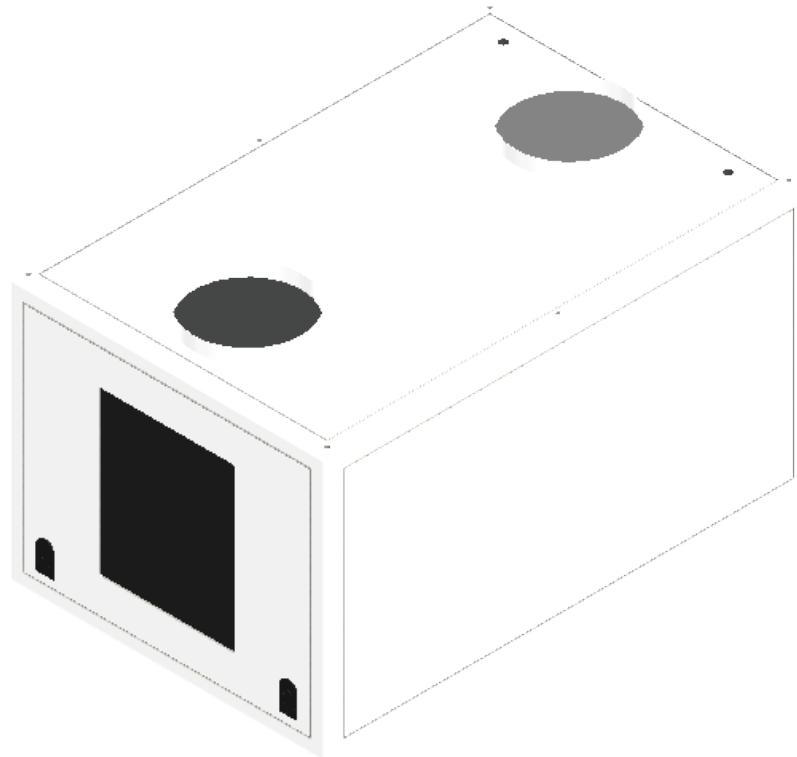

Air Inlet Duct Adapter/Filter

Exhaust Duct Adapter

Optical Grade Tempered Port Glass

Rigging Points:
6 x M12-1.75 x 38 threaded holes

Power and Signal Conduit Entries, EU PG21, US 3/4"

Lockable Door Latches front and back

DEC4 User Interface

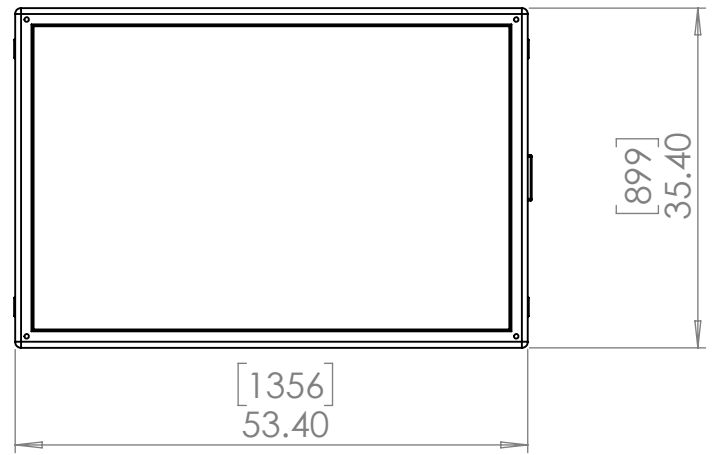
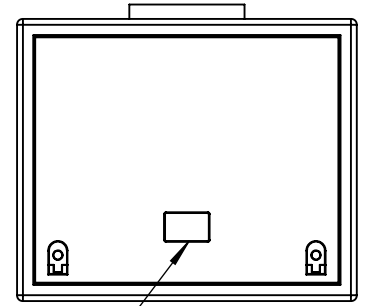
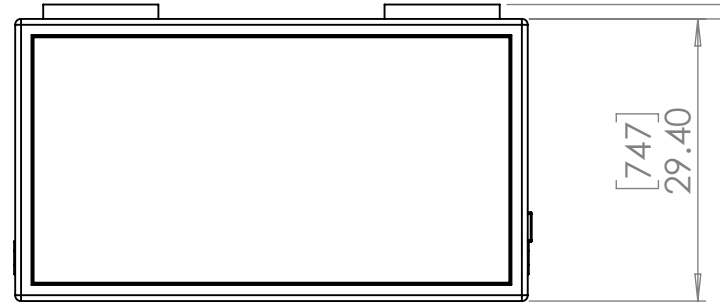
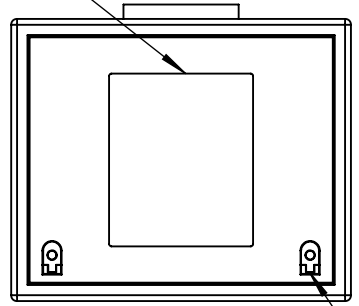
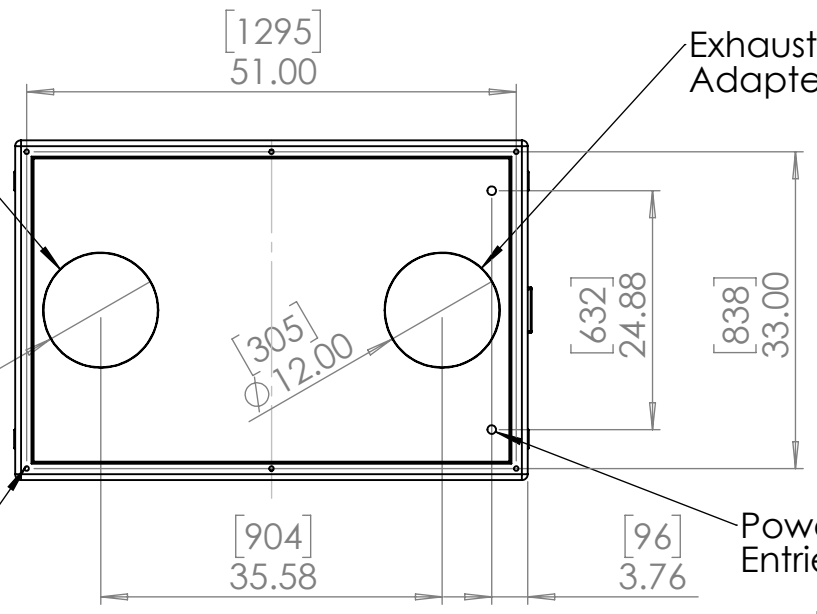

UNLESS OTHERWISE SPECIFIED:
DIMENSIONS ARE IN INCHES
TOLERANCES:
FRACTIONAL ±
ANGULAR: MACH ± BEND ±
TWO PLACE DECIMAL ±
THREE PLACE DECIMAL ±
INTERPRET GEOMETRIC TOLERANCING PER:
MATERIAL
Aluminum & SS
FINISH
RAL 9003 White
DO NOT SCALE DRAWING

	NAME	DATE
DRAWN	TB	12/10/2016
CHECKED		
ENG APPR.		
MFG APPR.		
Q.A.		
COMMENTS:		



TEMPEST
lighting inc.

TITLE:
Tacit G4 for Barco HDF-W30LP

SIZE	DWG. NO.	REV
B	56.360.L.xx	02

SCALE: 1:20 SHEET 1 OF 1