

For Remote Fan Assembly,
see drawing # 51.RFA.11

Inlet Duct Ring

Exhaust Duct Ring

Power & Signal Conduit Entries

Rigging Points:
M12-1.75, 6 places,
top and bottom

User Interface

Lockable Latches
front and back

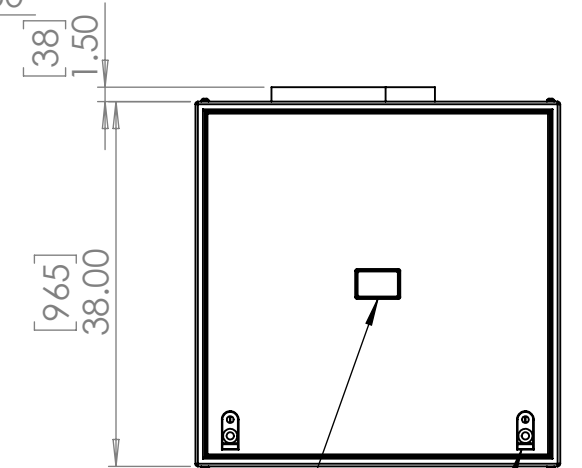
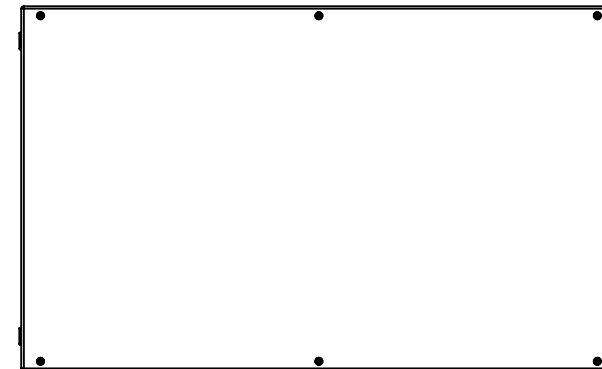
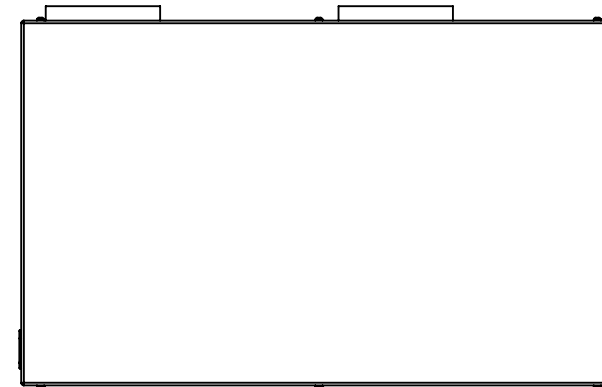
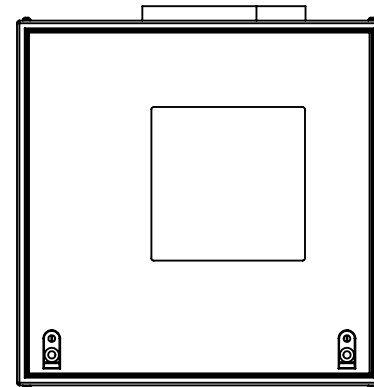
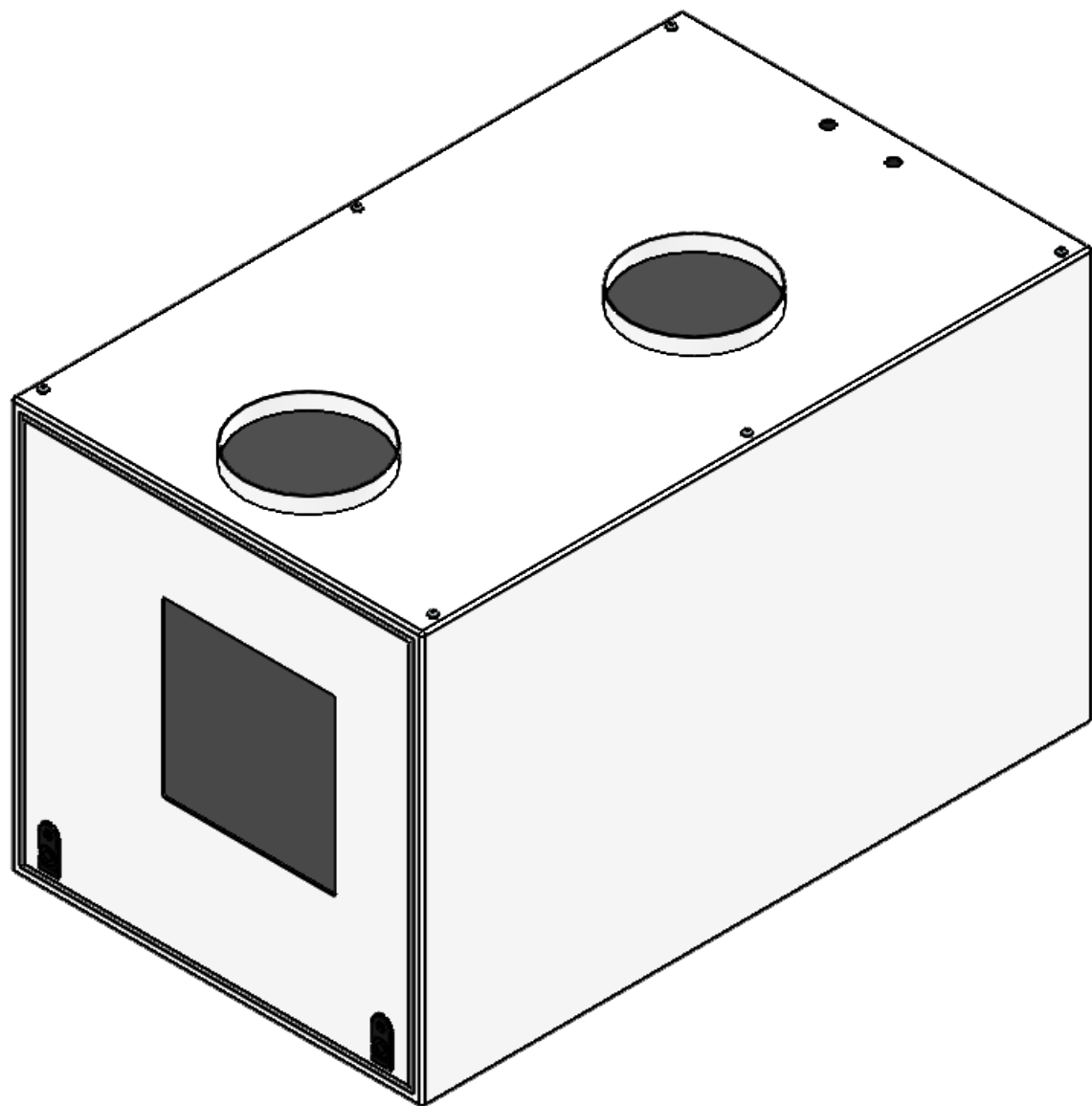

UNLESS OTHERWISE SPECIFIED:
DIMENSIONS ARE IN INCHES
TOLERANCES:
FRACTIONAL: ±
ANGULAR: MACH ± BEND ±
TWO PLACE DECIMAL ±
THREE PLACE DECIMAL ±
INTERPRET GEOMETRIC
TOLERANCING PER:

MATERIAL

FINISH

DO NOT SCALE DRAWING

	NAME	DATE
DRAWN	TB	5/3/2018
CHECKED		
ENG APPR.		
MFG APPR.		
Q.A.		
COMMENTS:		



TITLE:
Tacit 56.400 Landscape
Enclosure

SIZE	DWG. NO.	REV
B	56.400.L.xx	6.1

SCALE: 1:10 SHEET 1 OF 1