

8 7 6 5 4 3 2 1

D

D

C

C

B

B

A

A

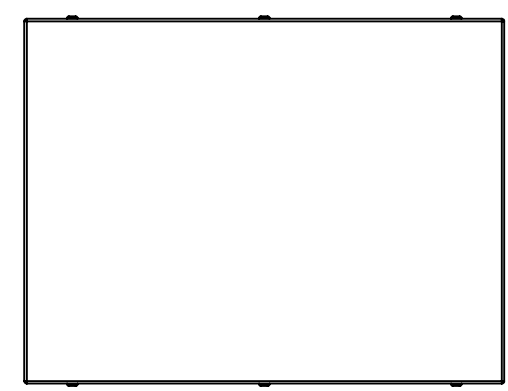
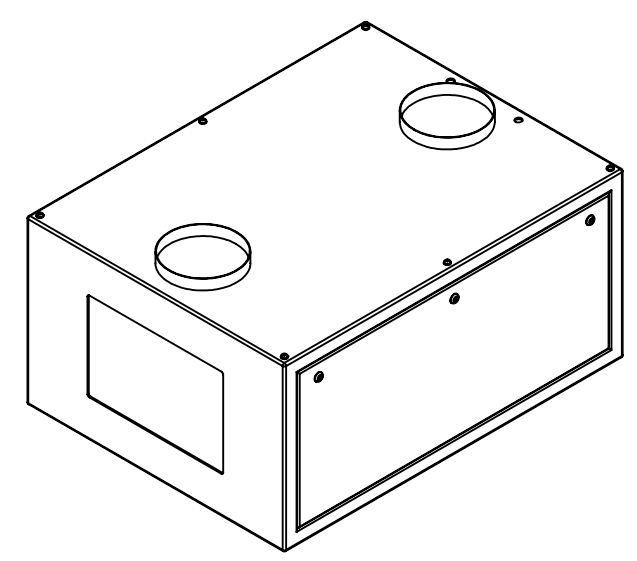
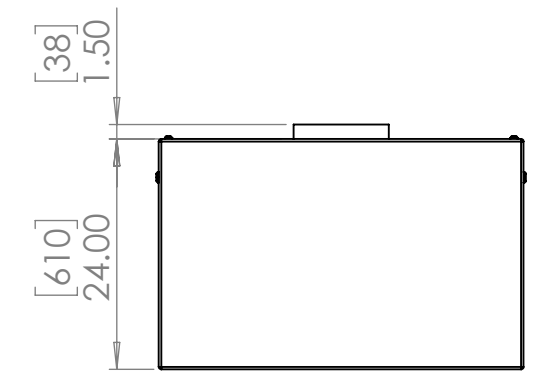
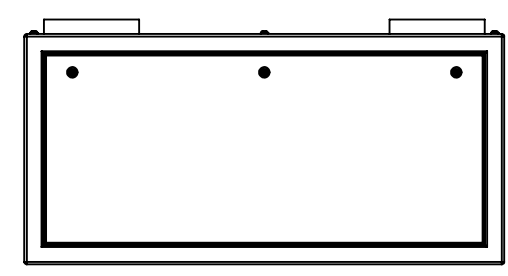
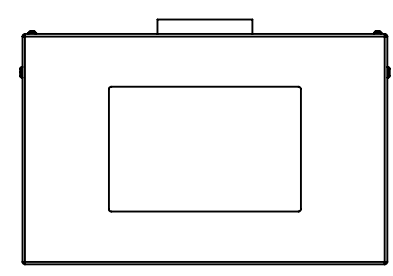
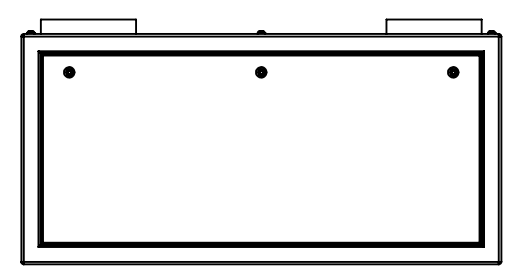
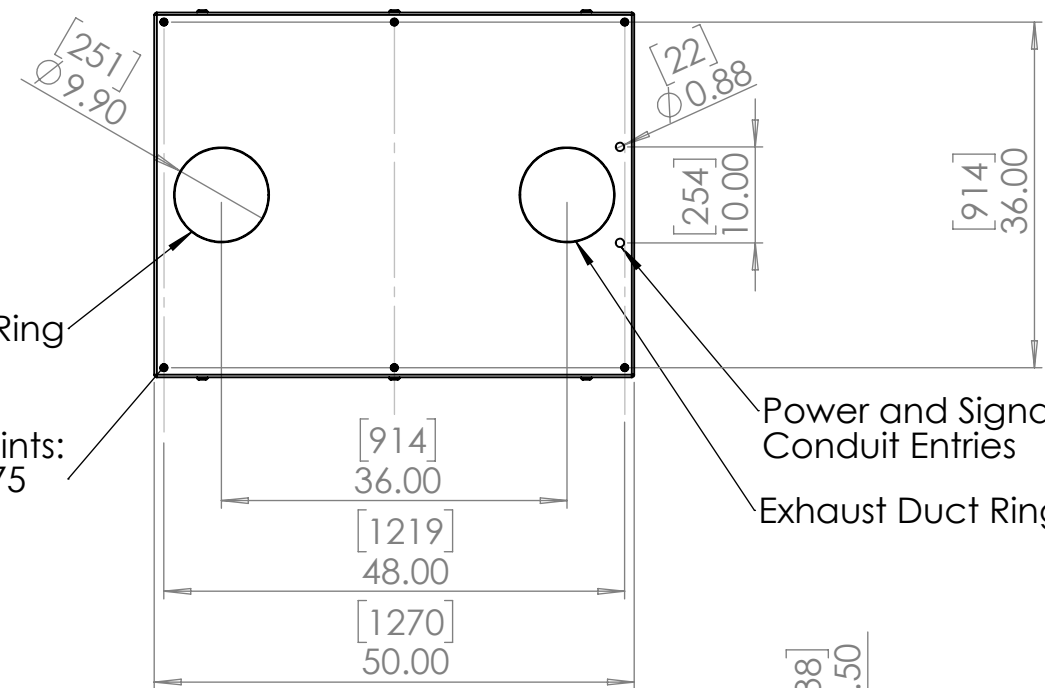

UNLESS OTHERWISE SPECIFIED:
 DIMENSIONS ARE IN INCHES
 TOLERANCES:
 FRACTIONAL ±
 ANGULAR: MACH ± BEND ±
 TWO PLACE DECIMAL ±
 THREE PLACE DECIMAL ±
 INTERPRET GEOMETRIC
 TOLERANCING PER:
 MATERIAL
 Aluminum
 FINISH
 TBD
 DO NOT SCALE DRAWING

	NAME	DATE
DRAWN	TB	8/5/2019
CHECKED		
ENG APPR.		
MFG APPR.		
Q.A.		
COMMENTS:		



TITLE:
 Tacit 56.250 Landscape
 Enclosure

SIZE	DWG. NO.	REV
B	56.250.L	07

SCALE: 1:20 SHEET 1 OF 1

8 7 6 5 4 3 2 1